

Pancake Day

1 Look and write.

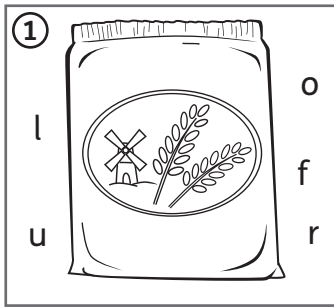

flour

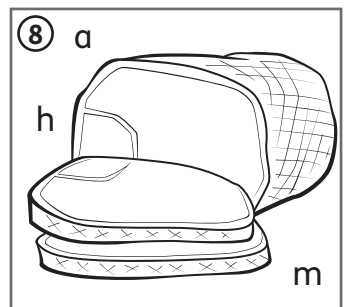
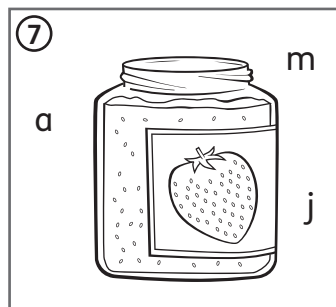
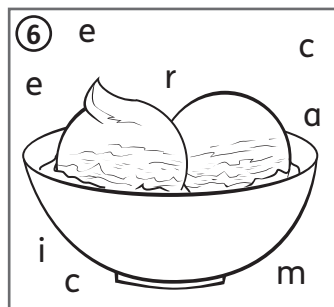
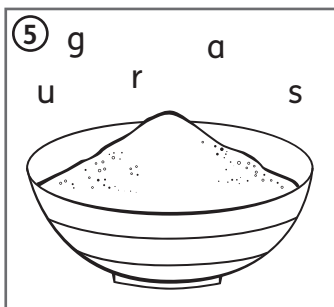
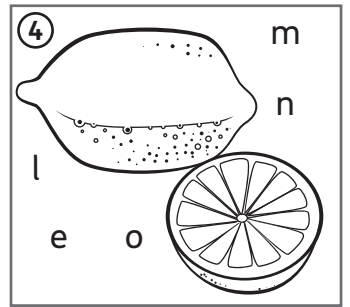
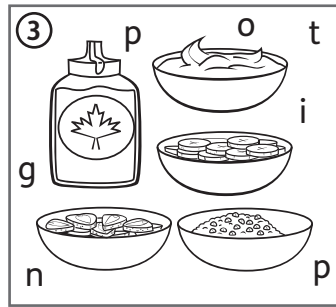
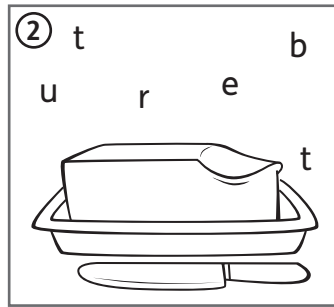

2 Read and tick ✓ A or B.



My favourite pancake topping is chocolate and strawberries. Look! There's a lot of chocolate and there are some strawberries.

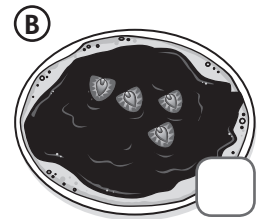
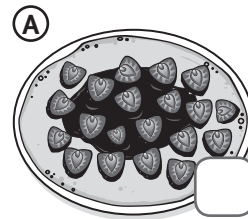

I want to make pancakes for my family. I've got six eggs, some flour and some butter. I haven't got any lemons.

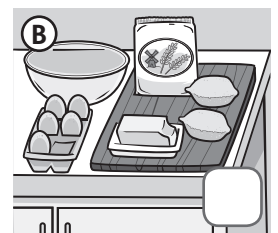
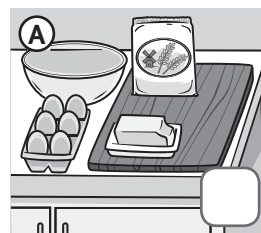

My dad likes ham on his pancakes. My mum likes jam on her pancakes.

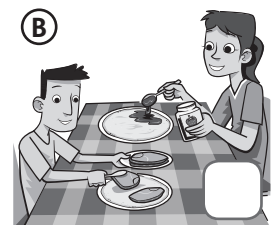
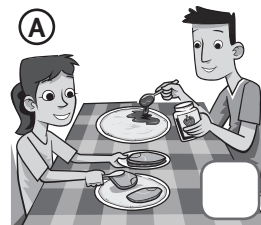

I'm making pancakes. I'm mixing the flour, milk and eggs. My brother is tossing the pancakes.

